

PRODUCT DATASHEET

PL COMP 600 V 33W 830 DALI

PANEL COMPACT 600 DALI | Square recessed panel luminaire, for 600 x 600 mm ceiling systems and DALI-2 technology



Areas of application

- Direct replacement for luminaires with fluorescent lamps
- Offices, conference rooms
- Reception areas, foyers, corridors, elevators
- Suitable for recessed ceiling systems with grid size of 600 x 600 mm

Product benefits

- Low flicker light thanks to special electronic control gear
- External driver for extended flexibility and easy installation
- Suitable for emergency lighting
- 5 years guarantee

Product features

- Suitable for central battery emergency installations acc. to EN 60598-2-22
- Push DIM function for dimming and switching directly on a pushbutton
- Extruded aluminum frame
- Polystyrene diffuser
- Lifetime (L80/B10): up to 50,000 h (at 25 °C)



TECHNICAL DATA

Electrical data

| | |
|---|---------------------|
| Nominal wattage | 33.00 W |
| Nominal voltage | 220...240 V |
| Mains frequency | 0/50/60 Hz |
| Nominal current | 190.000 mA |
| Inrush current | 1.7 A |
| Inrush current time T_{h50} | 52 μ s |
| Max. number of luminaires per miniature circuit breaker B16 | 83 |
| Max. number of luminaires per miniature circuit breaker C10 | 52 |
| Max. number of luminaires per miniature circuit breaker C16 | 83 |
| Power factor λ | > 0.90 |
| Total harmonic distortion | < 10 % |
| Protection class | II |
| Operating mode | External LED driver |
| Dimming interface | DALI-2 |

Photometrical data

| | |
|--|---------------------------|
| Luminous flux | 3630 lm |
| Luminous efficacy | 110 lm/W |
| Color temperature | 3000 K |
| Light color (designation) | Warm White |
| Color rendering index Ra | > 80 |
| Standard deviation of color matching | \leq 5 sdc _m |
| Low flicker | Yes |
| Flickering metric (Pst LM) | <1 |
| Stroboscope effect metric (SVM) | < 0.4 |
| Photobiological safety group acc. to EN62778 | RG0 |
| Beam angle | 120 ° |

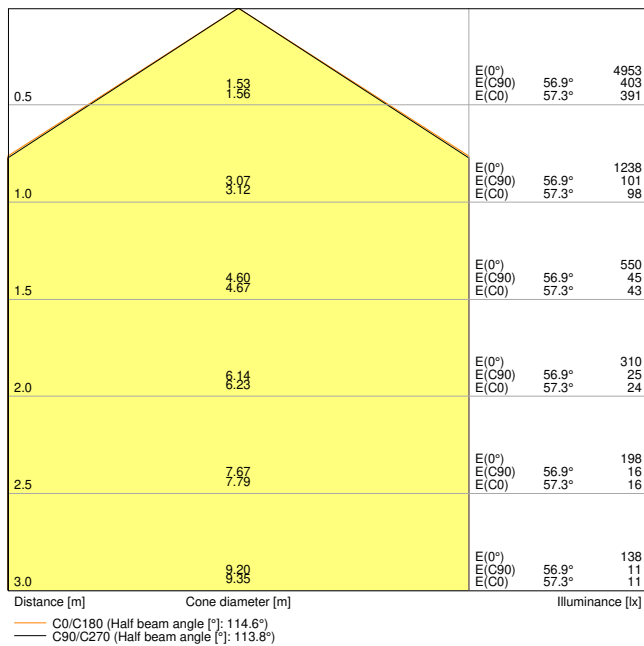

PL COMP 600 V 33W 830 DALI EM CONVERSION BOX

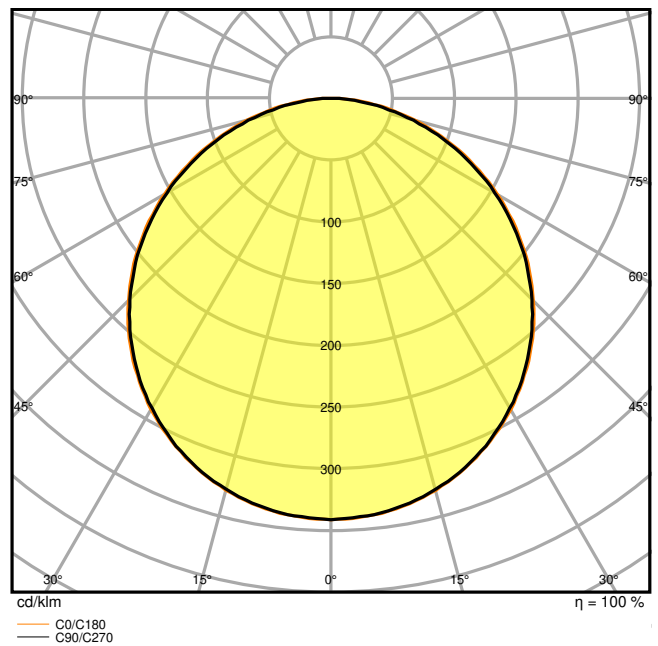

PL COMP 600 V 33W 830 DALI EM CONVERSION BOX

Dimensions & Weight

| | |
|----------------|-----------|
| Length | 595.00 mm |
| Width | 595.00 mm |
| Height | 32.00 mm |
| Product weight | 1543.00 g |

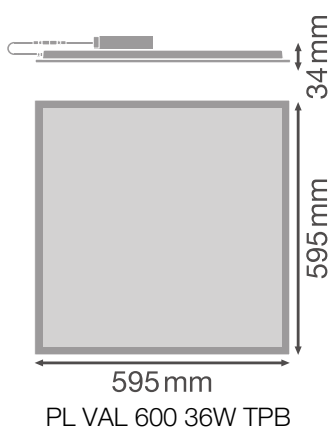

Materials & Colors

| | |
|--|------------------|
| Product color | White |
| Housing color | White |
| Body material | Steel |
| Cover material | Polystyrene (PS) |
| Light emitting surface material | Polystyrene |
| Glow Wire Test according to IEC 60695-2-12 | 650 °C |
| Mercury content | 0.0 mg |

Application & Mounting

| | |
|--|--|
| Ambient temperature range | -10...+45 °C |
| Temperature range at storage | -20...+70 °C |
| Type of connection | Screwless terminal, 4-Pole (L,N, DA+, DA-) |
| Type of protection | IP40/IP20 |
| Protection class IK (shock resistance) | IK02 |
| Dimmable | Yes |
| Type of dimming | DALI2 |
| Mounting type | Recessed/Suspended/Surface |
| Mounting location | Ceiling |
| Application environment | Indoor |
| Mounting length | 575 mm |
| Mounting width | 575 mm |
| Mounting depth | 50,0 mm |
| Adjustable | No |
| With light source | Yes |

Lifespan

| | |
|----------------------------|-----------------------|
| Lifespan L70/B50 at 25 °C | 70000 h ¹⁾ |
| Lifespan L80/B10 at 25 °C | 50000 h ¹⁾ |
| Lifespan L80/B50 at 25 °C | 50000 h |
| Lifespan L90/B10 at 25 °C | 40000 h |
| Number of switching cycles | 50000 |

¹⁾ t[h]: L70 / B50 @ 25 °C (Ta), t[h]: L80 / B10 @ 25 °C (Ta), t[h]: L90 / B10 @ 25 °C (Ta)

Control gear

| | |
|-----------------------------|--------|
| Output current | 700 mA |
| ECG - Output ripple current | < 7 % |

| | |
|--------------------------|--|
| ECG - Length | 168 mm |
| ECG - Width | 44 mm |
| ECG - Height | 32 mm |
| Recommended control gear | LEDV DR DALI-P-44/220-240/1050; Tridonic LCA 45W 500-1400mA one4all SC PRE |

Emergency lighting

| | |
|---|--------|
| Wattage in emergency operation mode | 5 W |
| Luminous flux in emergency operation mode | 400 lm |





Certificates & Standards





| | |
|--|-----------------------------------|
| Standards | CE / CB / ENEC / UKCA / EAC / EPD |
| Luminaire with limited surface temperature, "D sign" | No |
| Ball shot safe | No |
| EPD | LEDV-00008-V01.01-EN |
| Replaceable light source (EPREL) | Not replaceable |

Additional product data

| | |
|----------------|---------|
| Added function | VIVARES |
|----------------|---------|

Accessories Optional



| Product image | Product name | EAN |
|---|---------------------------------|---------------|
|  | DR DALI - P -44/220-240/1050 | 4058075779723 |
|  | DR AY ZB+DALI CLAMP DUO | 4058075483125 |
|  | EM CONVERSION BOX | 4058075237025 |
|  | PANEL 600 SURFACE MOUNT KIT H75 | 4058075472914 |





| Product image | Product name | EAN |
|--|-------------------------------------|---------------|
|  | PANEL 600 SURFACE MOUNT KIT H70 VAL | 4058075402843 |
|  | PANEL RECESSED MOUNT CLIPS VAL 4x | 4058075409859 |
|  | PANEL 600 RECESSED MOUNT FRAME | 4058075402881 |
|  | PANEL Suspension Kit | 4058075402928 |
|  | CONNECTOR BOX 5POLE L/N/PE/D+/D- 4x | 4058075473034 |







EQUIPMENT / ACCESSORIES



- Accessories for several mounting options available
- Security rope for luminaire included
- Security brackets preinstalled
- External control gear included
- Suitable for use with separate Emergency Conversion Box
- Connector box with 5-pole terminal for through-wiring separately available for cable cross sections up to 2.5 mm²

DOWNLOAD DATA

| Documents and certificates | Document name |
|---|----------------------------|
|  User instruction / safety instructions | PANEL COMPACT DALI |
|  Legal information | LISO Insert PL COMP 600 V |
|  Legal information | Legal Insert PANEL COMPACT |

| Documents and certificates | | Document name |
|--|---------------------------------|---|
|  | Legal information | EM Insert PL COMP |
|  | Legal information | Informationstext 18 Abs 4 ElektroG |
|  | Declarations of conformity | CE Declaration of Conformity PL COMP V DALI |
|  | Declarations of conformity UKCA | UKCA Declaration of Conformity PL COMP V DALI |

| Photometric and lighting design files | | Document name |
|--|-------------------------------------|--|
|  | IES file (IES) | PL COMP 600 V 33W 830 DALI EM CONVERSION BOX |
|  | LDT file (Eulumdat) | PL COMP 600 V 33W 830 DALI EM CONVERSION BOX |
|  | ULD file (DIALux) | PL COMP 600 V 33W 830 DALI |
|  | ROLF file (RELUX) | PL COMP 600 V 33W 830 DALI |
|  | UGR file (UGR table) | PL COMP 600 V 33W 830 DALI EM CONVERSION BOX |
|  | Light distribution curve type cone | PL COMP 600 V 33W 830 DALI EM CONVERSION BOX |
|  | Light distribution curve type polar | PL COMP 600 V 33W 830 DALI EM CONVERSION BOX |

| CAD/BIM files | | Document name |
|--|--------------|---------------|
|  | BIM Revit 3D | Panel Compact |
|  | CAD STEP 3D | PL COMP 600 |

| Tender texts | | Document name |
|--|------------------|--|
|  | Tender documents | PANEL COMPACT 600 DALI 33W 830 DALI-EN |

LOGISTICAL DATA

| Product code | Packaging unit (Pieces/Unit) | Dimensions (length x width x height) | Gross weight | Volume |
|---------------|------------------------------|--------------------------------------|--------------|-----------------------|
| 4099854017803 | Folding box 1 | 37 mm x 600 mm x 660 mm | 1907.00 g | 14.65 dm ³ |

| Product code | Packaging unit (Pieces/Unit) | Dimensions (length x width x height) | Gross weight | Volume |
|---------------|------------------------------|--------------------------------------|--------------|-----------------------|
| 4099854017810 | Shipping box 4 | 680 mm x 168 mm x 625 mm | 8558.00 g | 71.40 dm ³ |

The mentioned product code describes the smallest quantity unit which can be ordered. One shipping unit can contain one or more single products. When placing an order, for the quantity please enter single or multiples of a shipping unit.

ADDITIONAL CATALOG INFORMATION

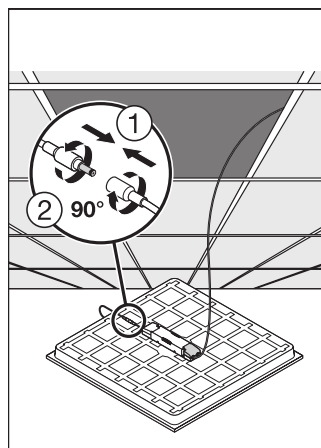
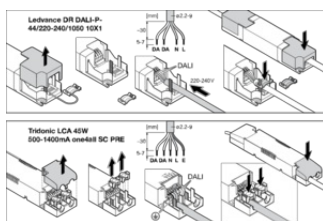

References / Links

– For Guarantee see www.ledvance.com/guarantee

DISCLAIMER

Subject to change without notice. Errors and omission excepted. Always make sure to use the most recent release.