



# LEDVANCE LOW VOLTAGE BATTERY SYSTEM

Installation and Operation Instructions

**LES-LV-5K**



LEDVANCE.COM



**LEDVANCE**

# CONTENT

---

Important information in the manual.....	1
Scope .....	1
Description of LES-LV-5K .....	1
Meaning of symbols.....	2
General safety information.....	4
Disclaimer.....	4
Proper use.....	5
Safety.....	6
Safety rules.....	6
Safety information.....	6
Scope of Delivery.....	7
LES-LV and LES-LV Base package.....	7
LES-LV-5K battery package.....	8
Battery system introduction.....	9
Operating panel.....	10
Number of battery modules supported by LES-LV-5K .....	11
Installation .....	12
Installation place requirement.....	12
Tools requirement.....	13
Installation steps.....	13
Product installation steps.....	14
Selection of installation sites.....	15
Definition of interface.....	15
Batteries in parallel.....	16
Single battery system.....	16
Commissioning.....	18
battery Run .....	18
The LED working status indication.....	18
Capacity indication.....	19
LED Flash instructions.....	19
Safety design.....	20
Electrical Schematic Diagram.....	20
Maintenance and storage.....	21
Cleaning.....	21
Storage.....	22
Disposal.....	22

## IMPORTANT INFORMATION IN THE MANUAL

### Scope

This installation and operation manual applies to the stackable battery energy storage system. Please carefully read this manual guide installation, preliminary debugging, and maintenance of LES-LV-5K Installation, preliminary debugging, and maintenance must be carried out by qualified and authorized engineer. Please keep this installation and operation manual and other applicable documents near the battery energy storage system, so that all engineer involved in installation or maintenance can access this installation and operation manual at any time.

### Description of LES-LV-5K

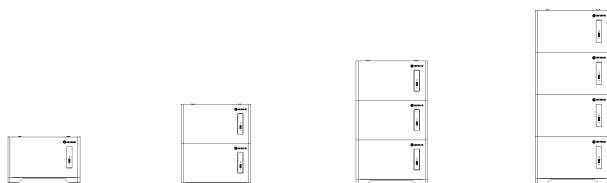

Module	LES-LV-5K 51.2V 5.12K	LES-LV-5K 51.2V 10.24K	LES-LV-5K 51.2V 15.36K	LES-LV-5K 51.2V 20.48K
Battery module number	1	2	3	4
Nominal voltage (V)	51.2			
Operating voltage (V)	40-58.4			
Nominal capacity (Ah)	100	200	300	400
Nominal energy (kWh)	5.12	10.24	15.36	20.48
Available energy (kWh)	4.864	9.728	14.592	19.456
Recommended Discharge current(A)	50	100	200	200
Max discharge current (A)	50	100	150	200
Max charge current (A)	100	200	200	200
Depth Discharge(%)	95%			
Discharge temperature (°C)	-20~60			
Charge temperature (°C)	0~55			
Battery Storage Temperature (°C)	0~35 ≤ six months			
Warranty period	10 years			

# IMPORTANT INFORMATION IN THE MANUAL

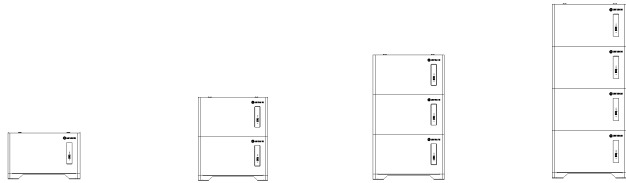

Terminal	ES07			
Communication	CAN 2.0 / RS485			
SOC display	4LED ( 25% , 50% , 75% , 100% )			
install	Floor mount			
Dimension W*D*H (mm)	680*152*430	680*152*810	680*152*1190	680*152*1570
Weight (kg)	48	93.5	139	184.5
Humidity	5% ~ 95%RH			
Altitude m	≤2000			
IP Rating of Enclosure	IP65			
Certificate	IEC 62619/EMC/UN38.3/CE			
Extensibility	Up to 8 systems can be used in parallel			

## Meaning of Symbols

This manual contains the following types of warnings:



**Danger!** It may cause an electric shock.

Even when the equipment is disconnected from the grid, the voltage-free state will have a time lag.



**Danger!** If the instructions are not observed, death or severe injury may occur.



**Warning!** If the instructions are not observed, a loss may occur.



**Attention!** This symbol represents information on the device use.

## IMPORTANT INFORMATION IN THE MANUAL

---

The following types of warning, prohibition, and mandatory symbols is important.

---



### **Attention! The risk of chemical burns**

If the battery is damaged or fails, it may lead to electrolyte leakage, which in turn causes the formation of a small amount of hydrofluoric acid, among other effects. Contact with these liquids can cause chemical burns.

- Do not subject the battery module to severe impact.
  - Do not open, disassemble or mechanically change the battery module.
  - In case of contact with an electrolyte, wash the affected area with clean water immediately and seek medical advice promptly.
- 



### **Attention! The risk of explosion**

Incorrect operation or fire may cause the lithium-ion battery unit to ignite or explode, leading to serious injury.

- Do not install or operate the battery module in explosive or high-humidity areas.
  - Store the battery module in a dry place within the temperature range specified in the datasheet.
  - Do not open, drill through or drop the battery cell or module.
  - Do not expose the battery cell or module to high temperatures.
  - Do not throw the battery cell or module into the fire.
  - If there is a fire from the battery, please use the CO<sub>2</sub> extinguisher. If there is a fire near the battery, please use a dry powder extinguisher.
  - Do not use defective or damaged battery modules.
- 



### **Caution! Hot surface**

- If a malfunction occurs, the parts will become very hot, and touching them may cause serious injury.
  - If the energy storage system is defective, please shut it down immediately.
  - If the fault or defect becomes obvious, special care should be taken when handling the equipment.
- 



### **No open fire!**

It is prohibited to handle open flames and ignition sources near the energy storage system.

---



### **Do not insert any objects into the opening in the housing of the energy storage system!**

No objects, such as screwdrivers, may be inserted through openings in the casing of the storage system.

---

## IMPORTANT INFORMATION IN THE MANUAL

---



**Wear safety goggles!** Wear safety goggles when working on the equipment.

---



**Follow the manual!**

When working and operating the equipment, the installation and operation manual provisions must be observed.

---

### General Safety Information



**Danger!** Failure to comply with the safety information can lead to life-threatening situations.

1. Improper use can cause death. Operators of LES-LV-5K must read this manual and observe all safety information .
2. Operators of LES-LV-5K must comply with the specifications in this manual.
3. This manual cannot describe all conceivable situations. For this reason, applicable standards and relevant occupational health and safety regulations are always given priority.
4. In addition, the installation may involve residual hazards in the following circumstances:
  - Incorrect installation.
  - The installation is carried out by personnel who did not receive relevant training or guidance.
  - Failure to observe the warnings and safety information in this manual.

### Disclaimer

**LESPOWER shall not be liable for personal injury, property loss, product damage and subsequent losses under the following circumstances.**

- Failure to comply with the provisions of this manual.
- Incorrect use of this product.
- Unauthorized or unqualified personnel repair the product, disassembly the rack and perform other operations.
- Use of unapproved spare parts.
- Unauthorized modifications or technical changes to the product.

## IMPORTANT INFORMATION IN THE MANUAL

---

### Proper Use

- The battery energy storage system can only be installed and operated under the eaves or indoors. The working environment temperature range of LES-LV-5K is  $-20\text{ }^{\circ}\text{C}$  ~  $50\text{ }^{\circ}\text{C}$ , and the maximum humidity is 90%. The battery module shall not be exposed to the sun or placed directly beside the heat source.
- The battery module shall not be exposed to a corrosive environment.
- When installing the battery energy storage system, ensure that it stands on a sufficiently dry and flat surface with sufficient bearing capacity. Without the manufacturer's written approval, the installation site's altitude shall not be higher than 2,000 meters. The rated output power of the battery will decrease with the altitude.
- In areas where flooding may occur, care must be taken to ensure that the battery module is installed at a suitable height to prevent contact with water.
- The battery energy storage system must be installed in a fireproof room. This room must have no fire source and must be equipped with an independent fire alarm device, which complies with local applicable regulations and standards. Similar fire-proof requirements apply to other openings in the room (such as windows).

**Compliance with the specifications in this manual is also part of proper use.**

### Requirements for Installation Personnel

All work shall comply with local applicable regulations and standards.

The installation of LES-LV-5K can only be completed by electricians with all following qualifications:

- Trained in dealing with hazards and risks associated with the installation and operation of electrical equipment, systems, and batteries.
- Trained on installation and debugging of electrical equipment.
- Understanding and complying with the technical connection conditions, standards, guidelines, regulations, and laws applicable.
- Knowledge of handling lithium-ion batteries (transportation, storage, disposal, hazard source).
- Understanding and complying with this document and other applicable documents.

### Safety Rules

To avoid property damage and personal injury, the following rules shall be followed when working on the hazardous live parts of the battery energy storage system:

- It is available for use.
- Ensure that it will not restart.
- Make sure there is no voltage.
- Grounding protection and short circuit protection
- Cover or shield adjacent live parts.

### Safety information

Part damage or short circuit may cause electric shock and death. A short circuit can be caused by connecting battery terminals, resulting in current flow. This type of short circuit shall be avoided under any circumstances. For this reason, follow these instructions:

- Use insulated tools and gloves.
- Do not put any tools or metal parts on the battery module or high-voltage control box.
- When operating the battery, be sure to remove watches, rings, and other metal objects.
- Do not install or operate this system in explosive or high-humidity areas.
- When working on the energy storage system, first turn off the charging controller, then the battery, and ensure that they are not turned on again.

**Improper** use of the battery energy storage system can lead to death. The use of the battery energy storage system beyond its intended use is not allowed, because it may cause great danger.

**Improper** handling of the battery energy storage system can cause life-threatening risks, serious injury or even death.



**Warning! Improper use can cause damage to the battery cell.**

- Do not expose the battery module to rain or soak it in liquid.
  - Do not expose the battery module to a corrosive environment (such as ammonia and salt).
  - The battery energy storage system shall be debugged no later than six months after delivery.
-



## SCOPE OF DELIVERY

---

### LES-LV-5K Base packge



② 2M black external communication cable (RJ45 to M19)



④ 2M DC+ orange external power cable (2AWG/100A 1AWG/200A)

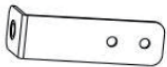

⑥ Wall fixing platex 2

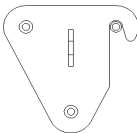

⑧ Box fixing platex 2

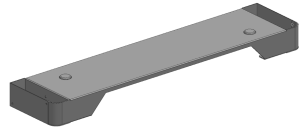

① LES-LV-5K Base x 1



③ 2M yellow-green grounding cable (8AWG)



⑤ 2M DC- black external power cable (2AWG/100A 1AWG/200A)



⑦ Screw (M4x4)



⑨ Product Manual

## SCOPE OF DELIVERY

---

### LES-LV-5K battery packge



LES-LV-5K x 1

LES-LV-5K Base package	
①	LES-LV-5K Base x 1
②	2M black external communication cable (RJ45 – M19)
③	2M yellow-green grounding cable (8AWG)
④	2M DC+ red external power cable (2AWG/100A 1AWG/200A)
⑤	2M DC- black external power cable (2AWG/100A 1AWG/200A)
⑥	Wall fixing plate x 2      Used to fix products on walls
⑦	Screw ( M4x4 )
⑧	Box fixing plate x 2
⑨	Product Manual
LES-LV-5K package	

## BATTERY SYSTEM INTRODUCTION

---

The Battery System LES-LV-5K is used as a connected battery for the intermediate storage of excess PV energy in an inverter system.

A	Switch
B	LED
C	battery module
D	battery base

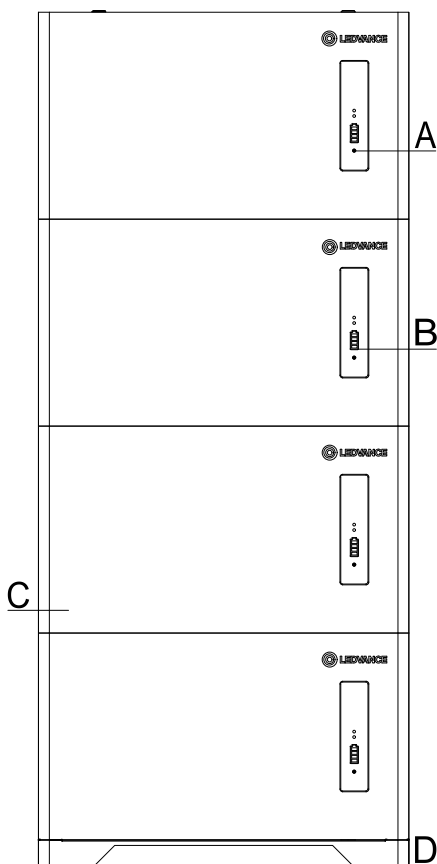

## BATTERY SYSTEM INTRODUCTION

### Operating Panel

#### 1) Switch and display interface

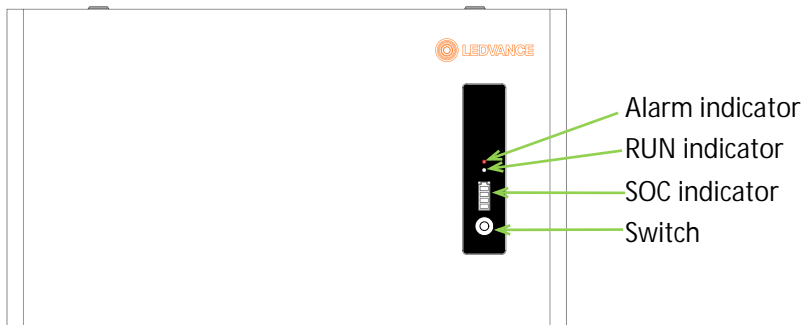

#### 2) Operating panel

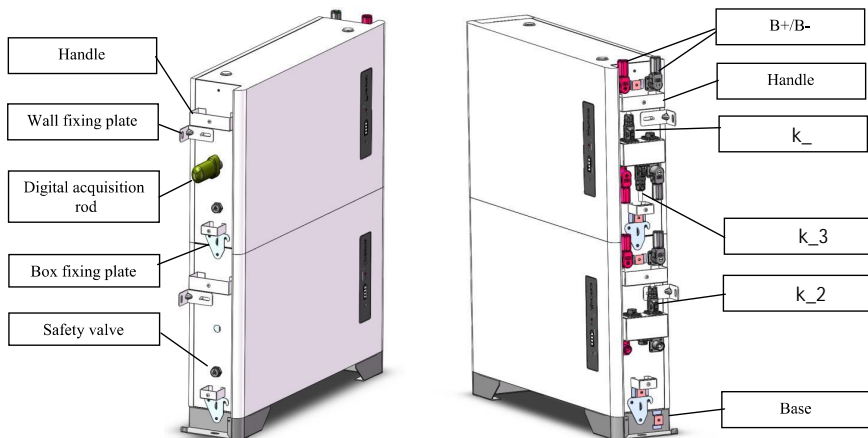

## BATTERY SYSTEM INTRODUCTION

---

### Number of battery modules supported by LES-LV-5K

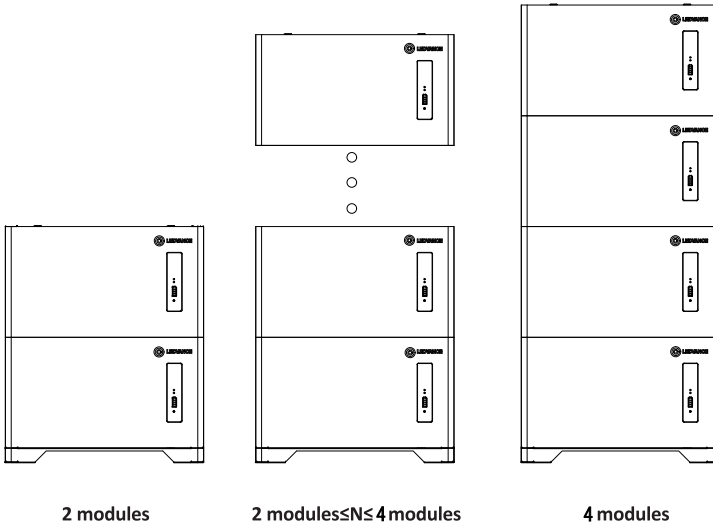

**Note:** Minimum two battery modules are required and Maximum four modules in one parallel.

## INSTALLATION

### Installation Place Requirement

- ① Installed on the surface with enough dryness, horizontal and flat, and has sufficient carrying capacity. (For example, concrete or masonry).
- ② The altitude of the installation location must not be higher than 2000 meters. (The output power of the battery will decrease with the height of the altitude).
- ③ If in the flood area, you must pay attention to ensure that the battery is installed in an appropriate altitude to prevent contact with water.
- ④ Ensure there is no fire source, and it must be equipped with an independent fire alarm device.
- ⑤ Cannot be exposed to corrosive environments.
- ⑥ The working temperature range should be  $-20^{\circ}\text{C}$  to  $60^{\circ}\text{C}$ .
- ⑦ The maximum environment humidity is 90%.
- ⑧ Can't be exposed to the sun or beside the heat source directly.
- ⑨ The installation site must be away from the children and the old.
- ⑩ The installation position must be compatible with the weight and size of the battery.

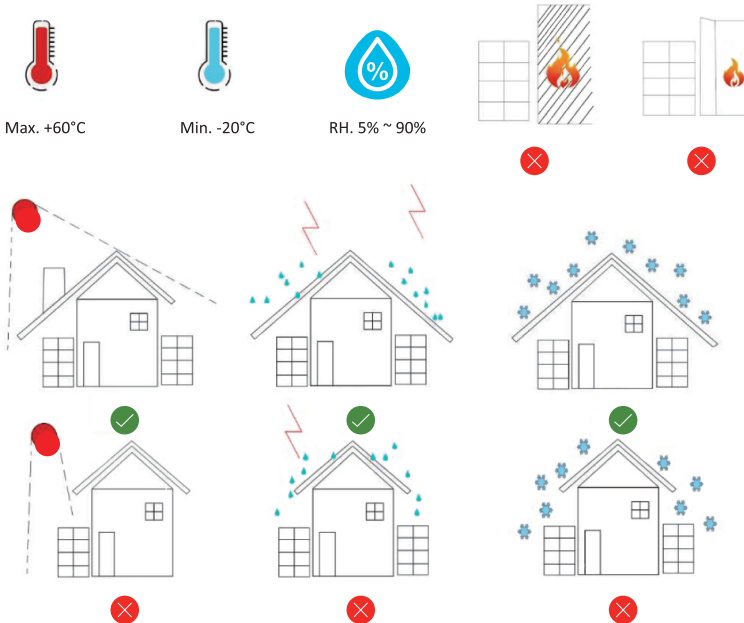

## INSTALLATION

---

### Tools Requirements:

1. When installing the battery system, wear the following safety equipment.



Gloves



Goggles



Safety Shoes

2. To install the battery system, you need the following tools



socket head wrench



External hexagonal wrench



electric drill

### ATTENTION!

- Because the DC cable or connector on the battery system may cause electric shock or life threatening life, do not contact the end of the non-insulating cable.
- If the battery module incorrectly lifts or falls in the process of transportation or installation, it may cause the risk of injury due to the weight of the battery module.
- Carefully transport and lift the battery module. Consider the weight of the battery module.
- For those who work for the battery system, please wear qualified personal protection equipment.

**Note: Before the battery is installed, please switch off the Switch .**

**Note: Wear gloves, goggles and safety shoes before installation.**

### Installation steps



#### CAUTION!

- ① Before installation, please make sure to wear the safety shoes to prevent foot injury.
- ② The weight of a battery module is over 30kg. please use the movable tools with two workers to complete stacking work .
- ③ Do not use the movable handle tool to carry the battery module when the distance is  $\geq 10m$ .
- ④ Before using the transport tools, check whether they are reliable.
- ⑤ The installation humidity ranges from 5 % to 90 %

## INSTALLATION

### Product Installation Steps

① Take out the base and battery module. Place the base on hard floor, lift the battery module on top of the base using a movable handle tool.

#### CAUTION!



After the battery module is connected to the base, the battery module plug-in port is electriferous. Take good insulation protection, pay attention to high voltage dangers and shot circuit dangers!

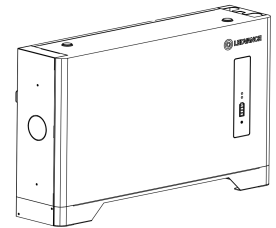
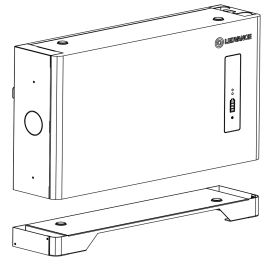

② Stack the corresponding connection ports at the bottom of the battery module. The number of stackable battery modules for a single battery system ranges from 2 to 4.

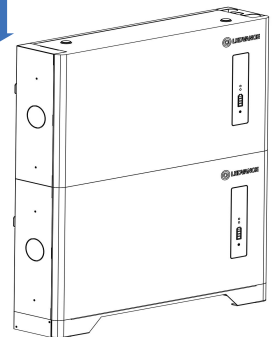
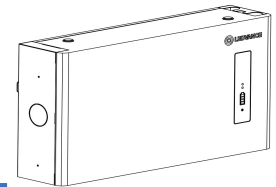

③ Attach the upper and lower stacked batteries with M4 \* 8 screws, and then mount the battery on the wall.

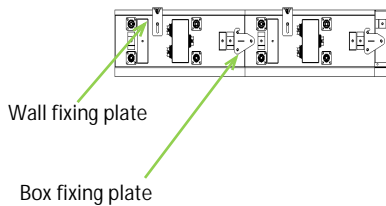



# INSTALLATION

## Selection of installation sites

The installation location is recommended to meet the size requirements of the figure below :

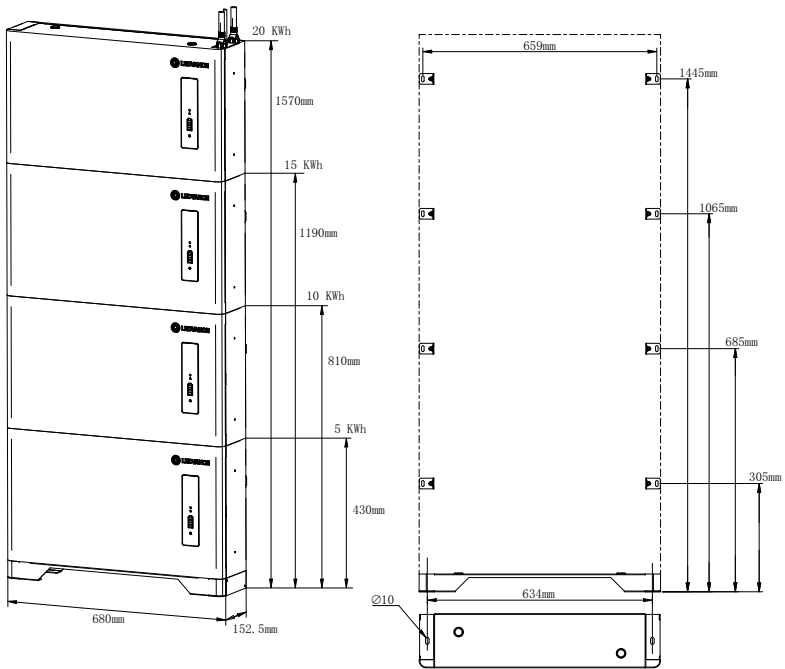

## INSTALLATION

### Selection of installation sites

The installation location is recommended to meet the size requirements of the figure below:

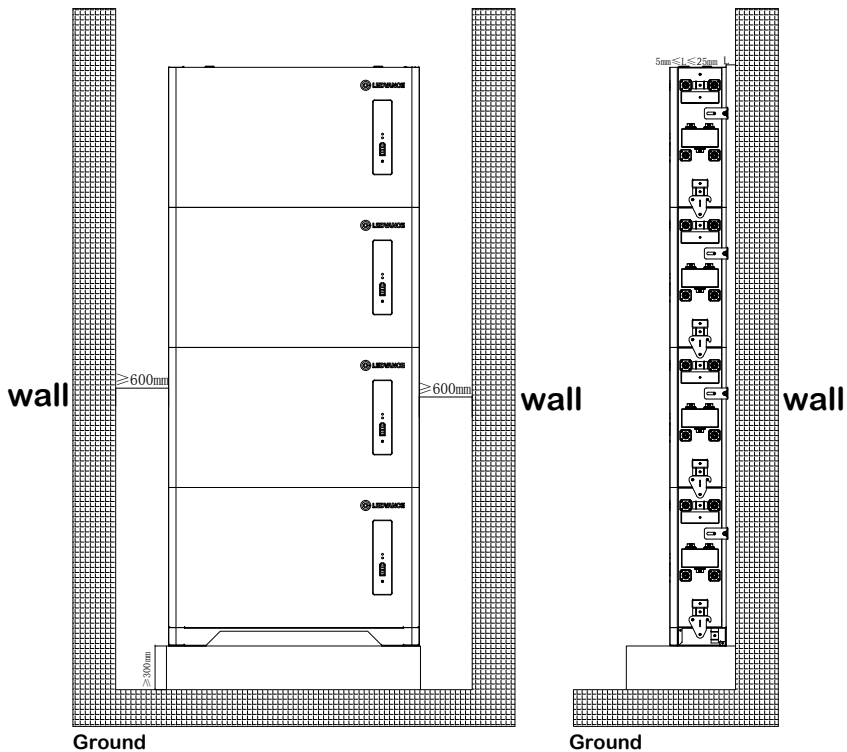

### Definition of Interface

Link_1	Link_2	Link_3
RS232-GND	1 RS485B	1 RS485B
RS232-GND	2 RS485A	2 RS485A
RS232-TX	3 UP_IN	3 DN_OP+
CAN_H	4 GND	4 GND
CAN_L	5	5
RS232-RX	6	6
RS485A1	7	7
RS485B1	8	8

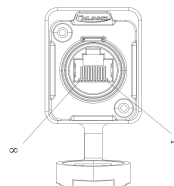

## INSTALLATION

### Batteries in parallel



#### CAUTION!

- ① The length of the power cables between the combiner box and the inverter.
- ② If the combiner box is not used, the parallel connection device should meet the following requirements.
  - a) No less than IP 55 for the outdoor use.
  - b) Maximum Operating Voltage, 60V DC.
  - c) Maximum Output Current, 100A DC.
- ③ The total power cable length between each battery cluster and the inverter should be less than 10 meters.

### Single Battery System

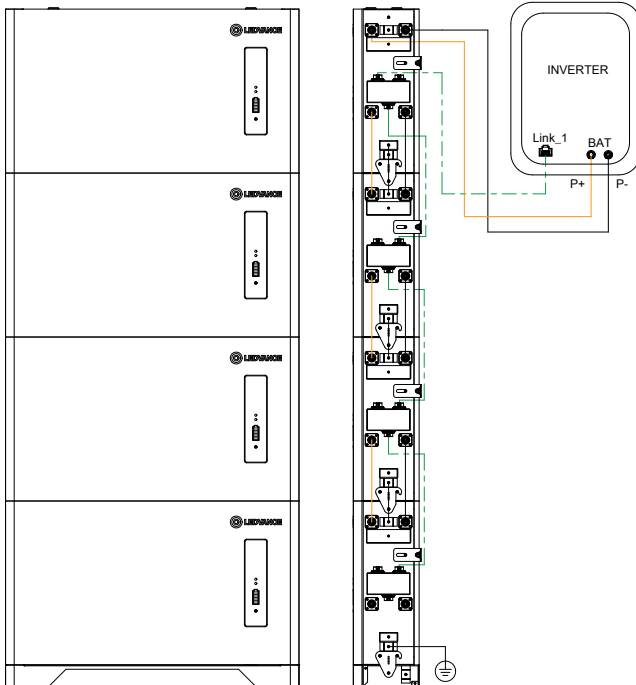

# COMMISSIONING

## battery Run

Requirements:

- The battery and the inverter must be properly installed and fixed.
- All cables must be correctly connected.

Recommended charge instructions:

Charge the battery at constant current 50A until voltage reaches 58.4V, then charge at constant voltage 58.4V till charge current is 5A.

### Steps:

When the battery is shut down, press the button (3-6S) to release, and the battery is active and power on, the LED indicator from "RUN" for 0.5 seconds to indicate the power on, after the RUN indicator is often on, the power indicator LED according to the current power indication.

When the battery is in the boot state, press the button (3-6S) to release, close the battery output, stop discharging, stop the LED indicator light and turn off from the lowest power light for 0.5 seconds.

The battery is in the state of parallel machine startup. After the main, main and negative total loop is connected with the communication line, the battery is startup in turn, in order to open the slave machine from the bottom to the top, and finally the host engine. The battery pack connected to the inverter is the host by default.

When the battery is in the state of parallel shutdown, first close the host connected to the inverter, and then turn off, the order is from top to bottom.

If it is failed to switch on the battery system.

**CONTACT OUR LOCAL AFTER-SALE SERVICE WITHIN 48 HOURS.**

## The LED working status indication

status	Normal / alarm / protection	RUN	ALM	Power instructions LED				instruction
		●	●	●	●	●	●	
shut down	dormancy	light goes out	light goes out	light goes out	light goes out	light goes out	light goes out	All lights go out
Standby	normal	Light flashing state 1	light goes out	According to the electricity instruction				stand by
	alarm	Light flashing state 1	3 Light flashing state 3	According to the electricity instruction				Module low pressure
charge	normal	The lights are always on	light goes out	According to the electricity instruction				
	alarm	The lights are always on	3Light flashing state 3	The lights are always on	The lights are always on	The lights are always on	The lights are always on	
	Temperature, over current, and failure protection	light goes out	The lights are always on	light goes out	light goes out	light goes out	light goes out	Stop charging
discharge	normal	Light flashing state 3	light goes out	According to the electricity instruction				
	alarm	Light flashing state 3	Light flashing state 3	According to the electricity instruction				
	Under voltage protection	light goes out	light goes out	light goes out	light goes out	light goes out	light goes out	Stop discharge
	Temperature, over current, short circuit, reverse connection, failure protection	light goes out	The lights are always on	light goes out	light goes out	light goes out	light goes out	Stop discharge

## COMMISSIONING

### Capacity indication

status		charge				discharge			
Capacity indicator light		L4●	L3●	L2●	L1●	L4●	L3●	L2●	L1●
quantity of electricity (%)	0~25%	light goes out	light goes out	light goes out	Light flashing state 2	light goes out	light goes out	light goes out	The lights are always on
	25~50%	light goes out	light goes out	Light flashing state2	The lights are always on	light goes out	light goes out	The lights are always on	The lights are always on
	50~75%	light goes out	2Light flashing state 2	The lights are always on	The lights are always on	light goes out	The lights are always on	The lights are always on	The lights are always on
	75~100%	Light flashing state 2	The lights are always on	The lights are always on	The lights are always on	The lights are always on	The lights are always on	The lights are always on	The lights are always on
Run the indicator light●		The lights are always on				Light flashing state 3			

### LED Flashinstructions

Flash mode	Light time	Turn off the lights time
Light flashing state1	0.25S	3.75S
Light flashing state2	0.5S	0.5S
Light flashing state3	0.5S	1.5S

## SAFETY DESIGN

- 1.The battery system cannot be turned on if the battery is incomplete or is not installed properly.2. The system will automatically shut down if the battery does not communicate with the inverter for 24 hours .
- 3.The system will automatically shut down if the battery or inverter installation error .
- 4.The battery voltage is too low and the low voltage alarm is triggered, after the operation for 30 seconds, the system will automatically turn off into hibernation and maintain the low power consumption state; Low power mode can be withdrawn into normal operation mode when any one of the following conditions is met:
  - 1) Access to the charger, and the output voltage of the charger shall be greater than 48V.
  - 2) Press the button (3-6S) and release the button.

## Electrical Schematic Diagram

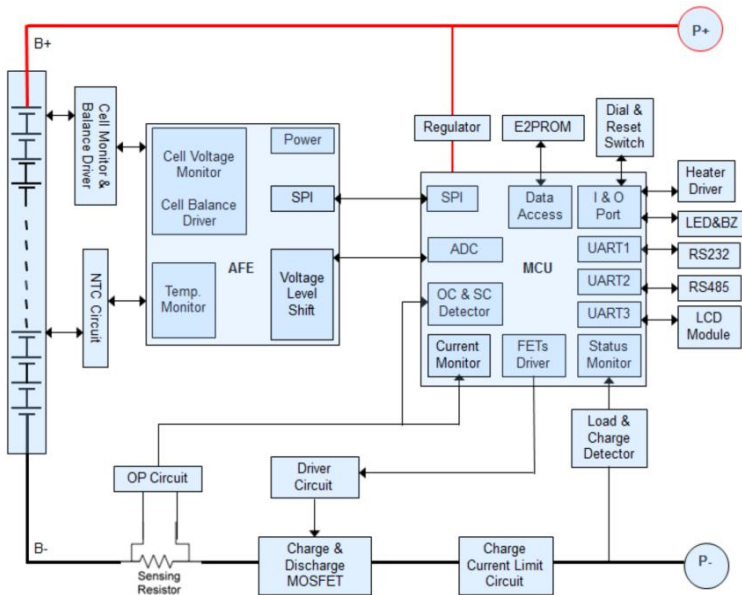

## MAINTENANCE AND STORAGE

---

### Cleaning

We recommend to clean the battery system regularly. If the battery housing is dirty, use a soft dry brush or dust collector to remove the dust. Do not use solvents, abrasives, or corrosive liquids to clean the housing.

### Storage

If the battery energy storage system will not be used for a long time, please refer to the following table to save the power. After charging, turn off all switches on the battery energy storage system to ensure the lowest system power consumption.

Storage environment temperature	Relative humidity of the storage environment	Storage time	SOC
Below-10°C	/	Not allowed	/
-10-25°C	5%-70%	≤12 months	25%≤SOC≤60%
25-35°C	5%-70%	≤6 months	25%≤SOC≤60%
35-50°C	5%-70%	≤3 months	25%≤SOC≤60%
Above 50°C	/	Not allowed	/

**Note: To ensure the battery service life, keep the storage temperature of the battery module between 0°C and 35°C.**

## DISPOSAL

---

For details related to the disposal of battery modules, please contact us.

Observe applicable regulations on waste battery disposal. Immediately stop the use of damaged batteries. Please contact your installer or sales partner before disposal. Ensure that the battery is not exposed to moisture or direct sunlight.

### Attention:

1. Do not dispose of batteries and rechargeable batteries as domestic waste!  
You are legally obliged to return used batteries and rechargeable batteries.
2. Waste batteries may contain pollutants that can damage the environment or your health if improperly stored or handled.
3. Batteries also contain iron, lithium and other important raw materials, which can be recycled.
4. Regulations vary for different countries. Dispose of in accordance with local regulation.

**Do not dispose of batteries as household waste!**



Corporate name LEDVANCE GmbH  
Company address: Steinerne Furt  
6286167 Augsburg Germany  
Contact Information: Krzysztof Rytel  
+48 734 134 386 k.rytel@ledvance.com